

Differential pressure sensor For ventilation and air-conditioning Model A2G-50

WIKA data sheet PE 88.02

for further approvals
see page 4

Applications

- For measuring differential pressures and static pressures
- Monitoring of filters
- Overpressure monitoring in clean rooms and laboratories

Special features

- Electrical output signal 0 ... 10 V or 4 ... 20 mA
- Modbus® output signal
- LC display
- Maintenance-free
- Maximum operating pressure 20 kPa



Differential pressure sensor, model A2G-50

Description

The model A2G-50 differential pressure sensor is used for measuring differential pressures of gaseous media in ventilation and air-conditioning applications.

It is based on the piezoresistive measurement principle. This compact differential pressure sensor offers excellent performance and high quality at an attractive price.

Electrical analogue output signals for both measurands (0 ... 10 V or 4 ... 20 mA) or the digital Modbus® versions enable the direct connection to control systems or the building automation system.

The pressure range as well as the unit and the response time can be individually adapted in the instrument via jumpers.

The measured differential pressure is also shown on the LC display and transmitted via the analogue or digital output signals. The LC display and the clear menu navigation enable a time-saving and simple commissioning.

Specifications

Differential pressure sensor, model A2G-50				
Version	<ul style="list-style-type: none"> ■ Version without LC display ■ Version with LC display 			
Measuring element	Piezo measuring cell			
Measuring range ¹⁾	Variant 1	Variant 2	Variant 3	Variant 4
	0 ... 2,500 Pa	0 ... 7,000 Pa	-250 ... +250 Pa	0 ... 12,000 Pa
	0 ... 2,000 Pa	0 ... 5,000 Pa	-100 ... +100 Pa	0 ... 10,000 Pa
	0 ... 1,500 Pa	0 ... 4,000 Pa	-50 ... +50 Pa	0 ... 9,000 Pa
	0 ... 1,000 Pa	0 ... 3,000 Pa	-25 ... +25 Pa	0 ... 8,000 Pa
	0 ... 500 Pa	0 ... 2,500 Pa	0 ... 250 Pa	0 ... 7,500 Pa
	0 ... 250 Pa	0 ... 2,000 Pa	0 ... 100 Pa	0 ... 7,000 Pa
	0 ... 100 Pa	0 ... 1,500 Pa	0 ... 50 Pa	-1,000 ... +1,000 Pa
	-100 ... +100 Pa	0 ... 1,000 Pa	0 ... 25 Pa	-500 ... +500 Pa
Accuracy ²⁾				
Measuring ranges 0 ... 250, 0 ... 2,500 Pa	Pressure < 125 Pa	1 % ±2 Pa		
	Pressure > 125 Pa	1 % ±1 Pa		
Measuring ranges 0 ... 7,000, 0 ... 12,000 Pa	Pressure < 125 Pa	1.5 % ±2 Pa		
	Pressure > 125 Pa	1.5 % ±1 Pa		
Units (adjustable in the menu)	<ul style="list-style-type: none"> ■ Pa ■ kPa ■ mbar ■ inWC ■ mmWC 			
Process connection	Connecting nozzle (ABS), lower mount, for hoses with inner diameter 4 ... 6 mm			
Supply voltage U_B				
With automatic zero point setting	AC 24 V or DC 24 V ±10 %			
Without automatic zero point setting	Output signal 0 ... 10 V	DC 14 ... 30 V or AC 24 V ±10 %		
	Output signal 4 ... 20 mA	DC 9 ... 30 V or AC 24 V ±10 %		
Electrical connection	Cable gland M16 Screw terminals max. 1.5 mm ²			
Output signal	<ul style="list-style-type: none"> ■ DC 0 ... 10 V, 3-wire ■ 4 ... 20 mA, 3-wire ■ Modbus® 			
Current consumption				
DC 0 ... 10 V	< 1.0 W			
4 ... 20 mA	< 1.2 W			
Modbus®	< 1.3 W			
Case	Plastic (ABS)			
Zero point setting	<ul style="list-style-type: none"> ■ Automatic ³⁾ ■ Manually via push button on the printed circuit board 			
Permissible temperatures				
Medium	<ul style="list-style-type: none"> ■ -20 ... +50 °C [-4 ... +122 °F] ■ -5 ... +50 °C [23 ... 122 °F], with automatic zero point setting 			
	Ambient	-40 ... +70 °C [-40 ... +158 °F]		
Ingress protection per IEC/EN 60529	IP54			
Weight	150 g			

1) The measuring range is set via jumpers within the selected variant.







2) All data refer to the current measured pressure.

3) The automatic zero point setting aligns the zero point from time to time so that a manual zero point setting is not necessary. During the zero point setting (3 seconds every 10 minutes), the output signal and the display show the last measured value. Recommended for measuring ranges < 250 Pa.

Modbus® version

Modbus® communication	
Protocol	Modbus® via serial interface
Measuring range	<ul style="list-style-type: none">■ -250 ... +2,500 Pa■ -250 ... +7,000 Pa
Transfer mode	RTU
Interface	RS-485
Byte format	(11 bits) in RTU mode Coding system: 8 bits binary Bits per byte: <ul style="list-style-type: none">■ 1 start bit■ 8 data bits, lowest-order bit is sent first■ 1 bit for parity■ 1 stop bit
Baud rate	<ul style="list-style-type: none">■ 9,600■ 19,200■ 38,400 Adjustable in the configuration
Modbus® addresses	1 ... 247 addresses selectable in the configuration menu

Approvals

Logo	Description	Country
	EU declaration of conformity <ul style="list-style-type: none"> ■ EMC directive ■ RoHS directive ■ WEEE directive 	European Union
	EAC (option) Import certificate	Eurasian Economic Community
	GOST (option) Metrology, measurement technology	Russia
	KazInMetr (option) Metrology, measurement technology	Kazakhstan
-	MTSCHS (option) Permission for commissioning	Kazakhstan
	UkrSEPRO (option) Metrology, measurement technology	Ukraine
	Uzstandard (option) Metrology, measurement technology	Uzbekistan

Certificates (option)

- Measurement report per EN 837
- 2.2 test report per EN 10204
- 3.1 inspection certificate per EN 10204

Approvals and certificates, see website

Electrical connection

Output signal DC 0 ... 10 V

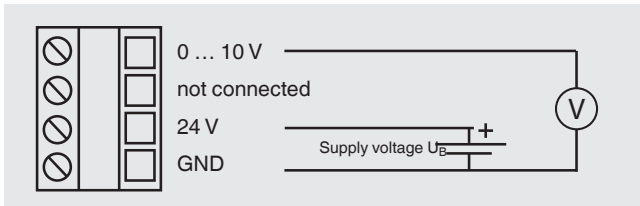

Output signal 4 ... 20 mA

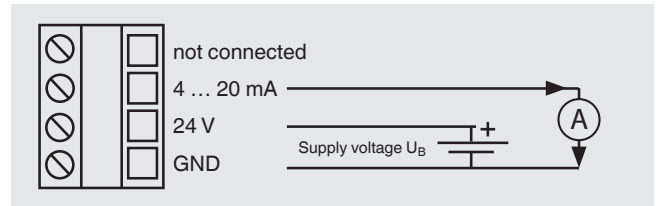

Modbus® output signal

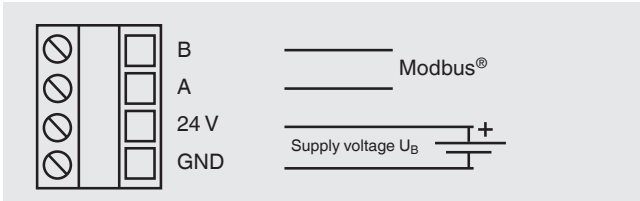

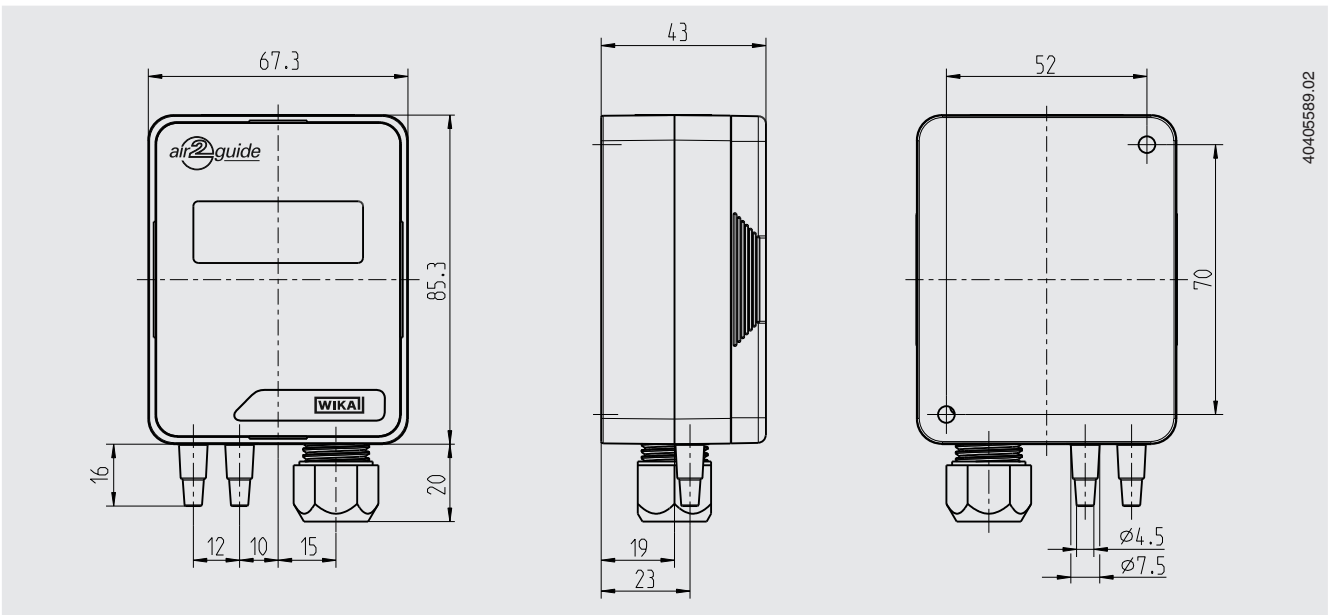

Dimensions in mm



40405589.02

Accessories

Description	Order number
	Static duct probes with combi hose connection for pressure measuring hoses Ø 4 ... 7 mm Insertion length 100 mm Insertion length 150 mm Insertion length 200 mm
	Measuring hoses PVC hose, inner diameter 4 mm, roll at 25 m PVC hose, inner diameter 6 mm, roll at 25 m Silicone hose, inner diameter 4 mm, roll at 25 m Silicone hose, inner diameter 6 mm, roll at 25 m
	Duct connectors for measuring hoses Ø 4 ... 6 mm

Ordering information

Model / Version / Measuring range / Output signal / Zero point setting / Accessories / Approvals / Certificates / Options

© 08/2008 WIKA Alexander Wiegand SE & Co. KG, all rights reserved.
 The specifications given in this document represent the state of engineering at the time of publishing.
 We reserve the right to make modifications to the specifications and materials.



WIKA Alexander Wiegand SE & Co. KG
 Alexander-Wiegand-Straße 30
 63911 Klingenberg/Germany
 Tel. +49 9372 132-0
 Fax +49 9372 132-406
 info@wika.de
 www.wika.de